

A stainless steel industrial machine with a large funnel on top and a control panel on the left. The control panel has a small screen and a red emergency stop button. A red banner is overlaid on the top left.

# SAMS.19.01



## SOP Recipe Management

Store up to 10 Pre-set



## Large Diameter Input with 8" Funnel

DN65 Tri-Clamp 65mm Input Diameter



## Food Safe Design

304/316 Stainless Steel Construction Smooth





## Contact Us:

☎ US: +1 (603) 800 1799

@ sales@sampleautomation.com





## Controls

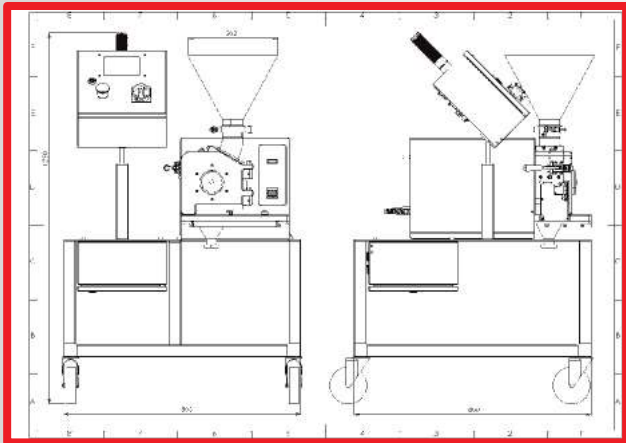

-  5.7" Touch Screen HMI
-  Emergency Stop and Isolation Switch
-  Automated Auxillary Controls
-  SOP Recipe Speed and Setting Controls
-  Password Setting Controls
-  Stainless Steel Display Enclosure
-  Stainless Steel Controller Enclosure
-  Smooth Finished Welds



## Electricals

-  110V Single Phase 50/60Hz -1725 watt, 8Nm
-  220V Double Phase 50/60Hz - 2350 watt, 10Nm
-  400V Three Phase 50/60Hz - 5000 watt, 30Nm

## Dimensions:

-  SAMS.19.01: without Cyclone (80cm L x 80cm W x 1250 H)
-  Weight: 150Kg

